

HL510N-3125

< 0,5 l/sec
DN 40/50

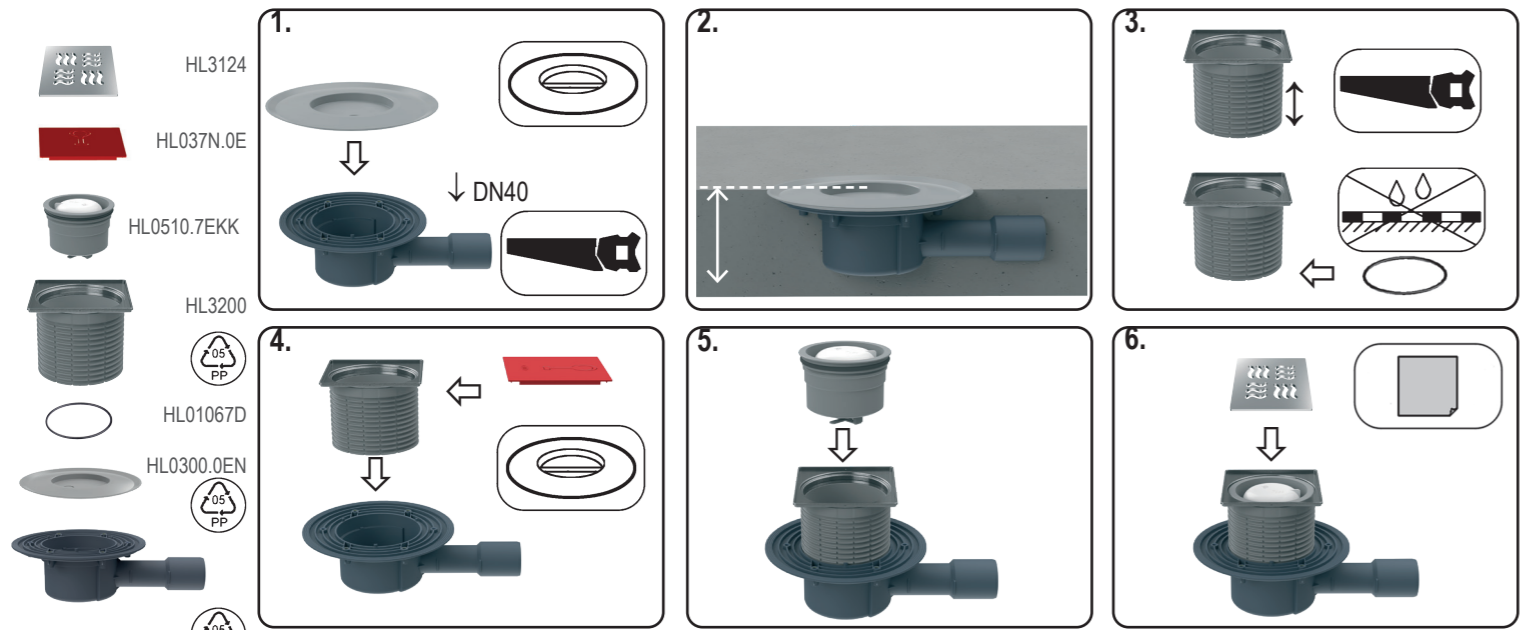
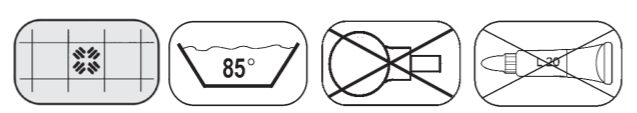

- HL3124
- HL037N.0E
- HL0510.7EKK
- HL3200
- HL01067D
- HL0300.0EN

D BODENABLAUF
IT SCARICO A PAVIMENTO
GB FLOOR DRAIN

TR YER SÜZGEÇİ
CZ/SK PODLAHOVÁ VPUST
HR PODNI ODVOD

HU PADLÓLEFOLYÓ
PL WPUST PODLOGOWY
SI TALNI ODTOK

RO SIFON DE PARDOSEALĂ
RU ТРАП
BG ПОДОВ СИФОН

27.02.2024

HL510N-3125

< 0,5 l/sec
DN 40/50

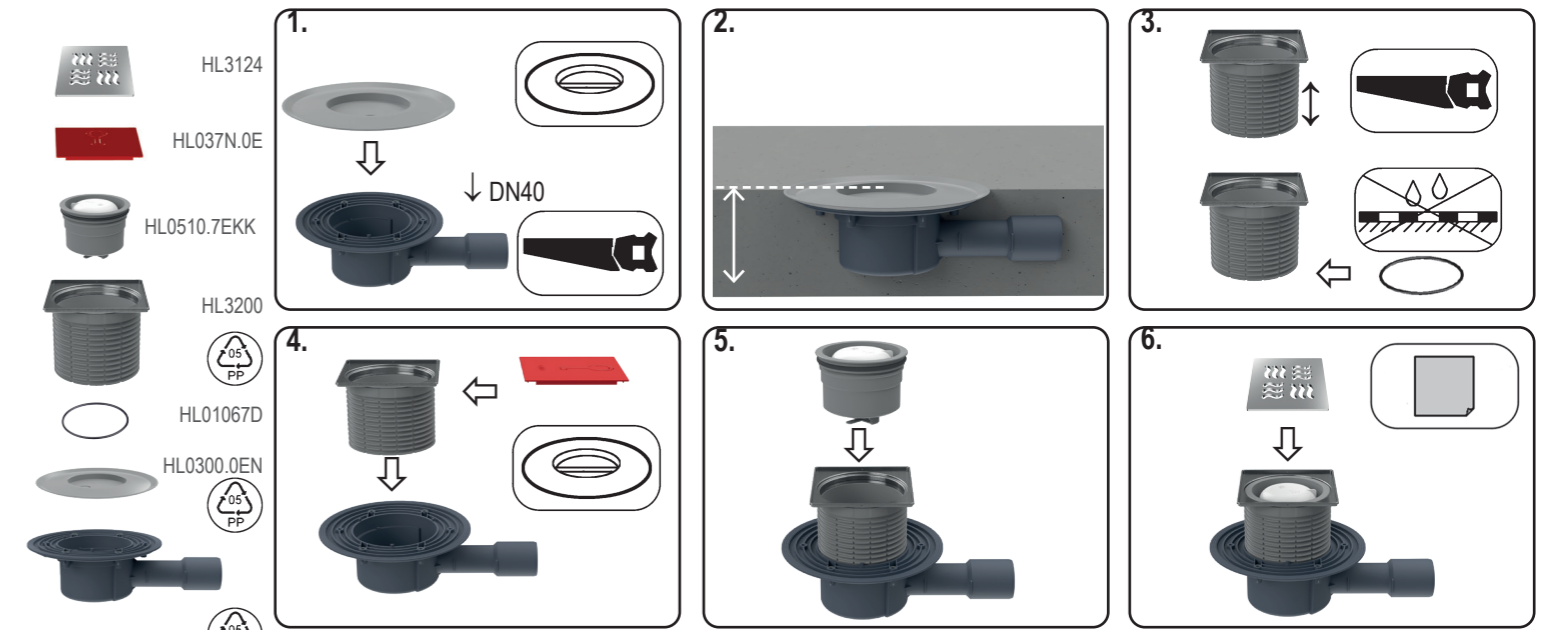
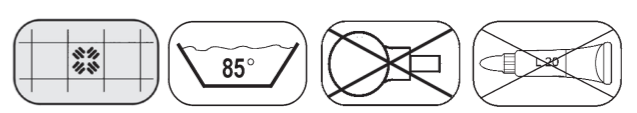

- HL3124
- HL037N.0E
- HL0510.7EKK
- HL3200
- HL01067D
- HL0300.0EN

D BODENABLAUF
IT SCARICO A PAVIMENTO
GB FLOOR DRAIN

TR YER SÜZGEÇİ
CZ/SK PODLAHOVÁ VPUST
HR PODNI ODVOD

HU PADLÓLEFOLYÓ
PL WPUST PODLOGOWY
SI TALNI ODTOK

RO SIFON DE PARDOSEALĂ
RU ТРАП
BG ПОДОВ СИФОН

27.02.2024

HL510N-3125

< 0,5 l/sec
DN 40/50

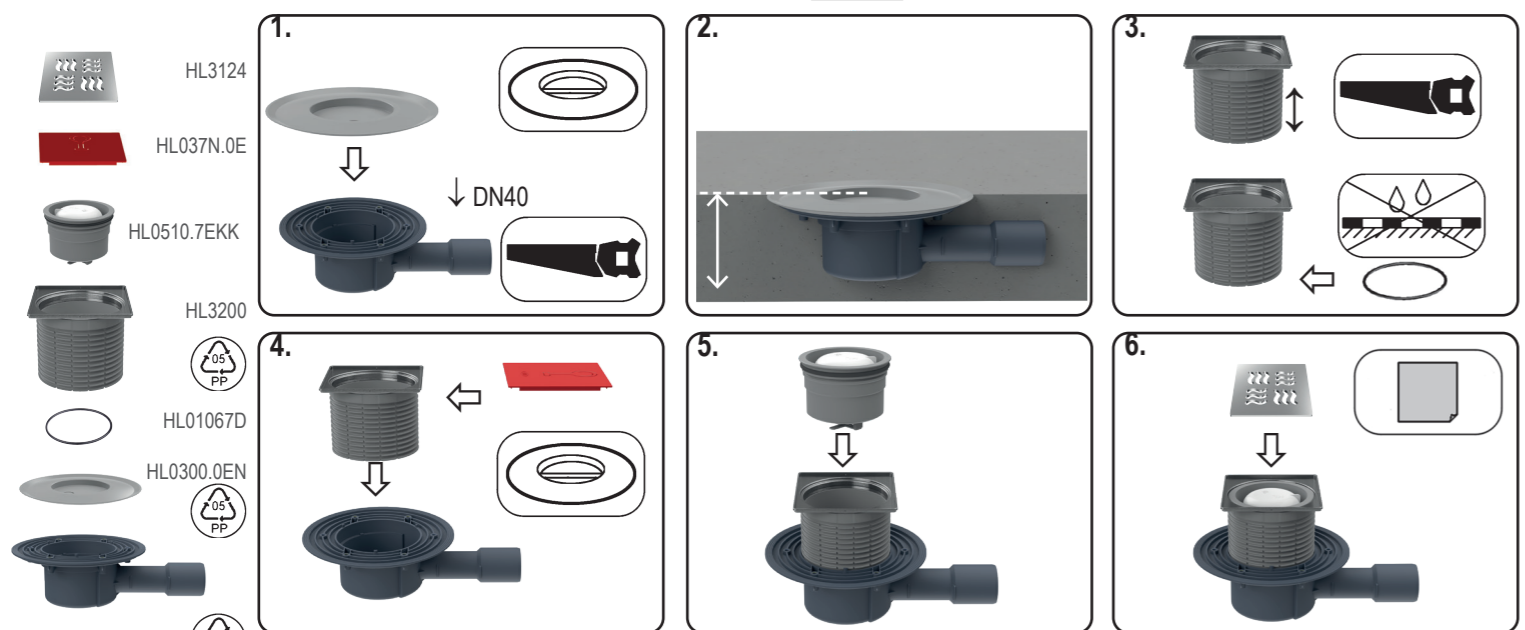
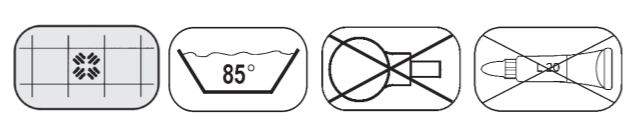

- HL3124
- HL037N.0E
- HL0510.7EKK
- HL3200
- HL01067D
- HL0300.0EN

D BODENABLAUF
IT SCARICO A PAVIMENTO
GB FLOOR DRAIN

TR YER SÜZGEÇİ
CZ/SK PODLAHOVÁ VPUST
HR PODNI ODVOD

HU PADLÓLEFOLYÓ
PL WPUST PODLOGOWY
SI TALNI ODTOK

RO SIFON DE PARDOSEALĂ
RU ТРАП
BG ПОДОВ СИФОН

27.02.2024

HL510N-3125

< 0,5 l/sec
DN 40/50

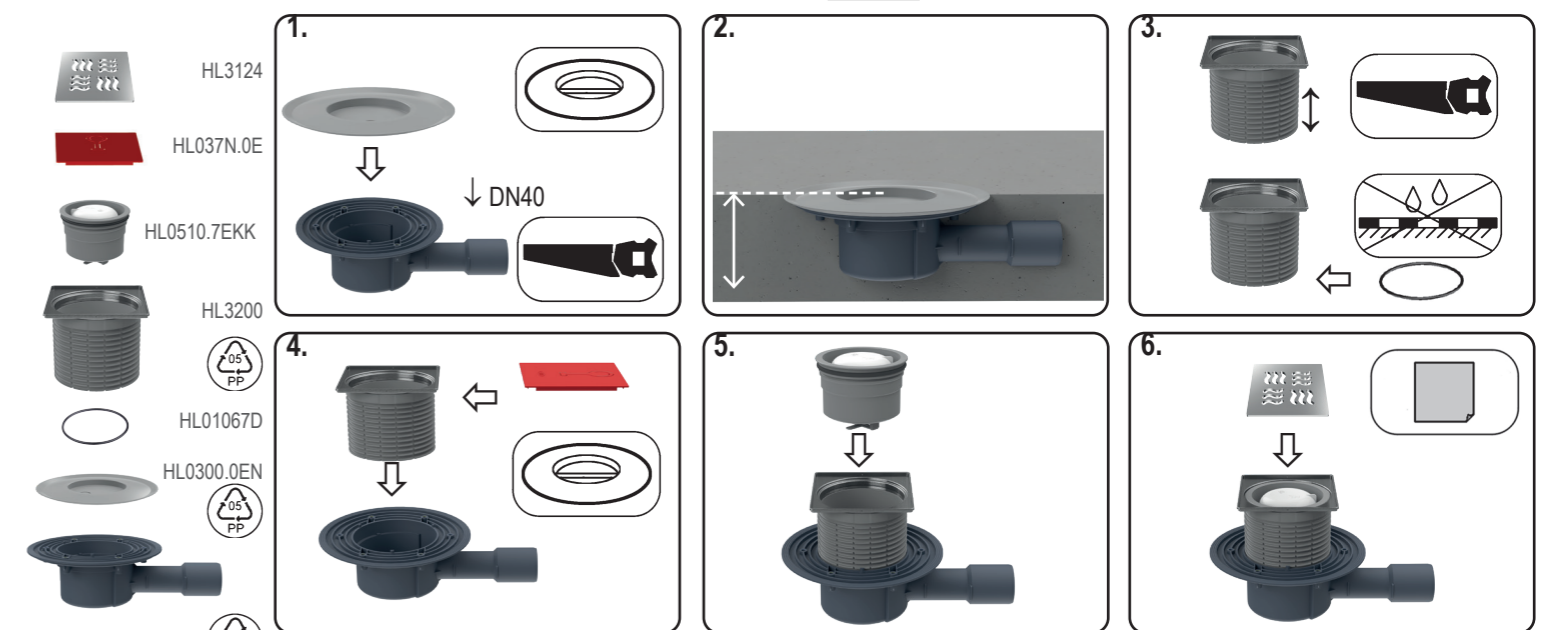
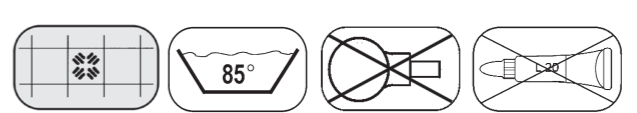

- HL3124
- HL037N.0E
- HL0510.7EKK
- HL3200
- HL01067D
- HL0300.0EN

D BODENABLAUF
IT SCARICO A PAVIMENTO
GB FLOOR DRAIN

TR YER SÜZGEÇİ
CZ/SK PODLAHOVÁ VPUST
HR PODNI ODVOD

HU PADLÓLEFOLYÓ
PL WPUST PODLOGOWY
SI TALNI ODTOK

RO SIFON DE PARDOSEALĂ
RU ТРАП
BG ПОДОВ СИФОН

27.02.2024